

СХЕМЫ ДЛЯ УСТАНОВКИ ПОДОГРЕВАТЕЛЯ ДВИГАТЕЛЯ- DEFA 411381.

На нижеуказанных рисунках показано расположение установочных отверстий в блоке двигателя, относительно моделей и марок транспортных средств.

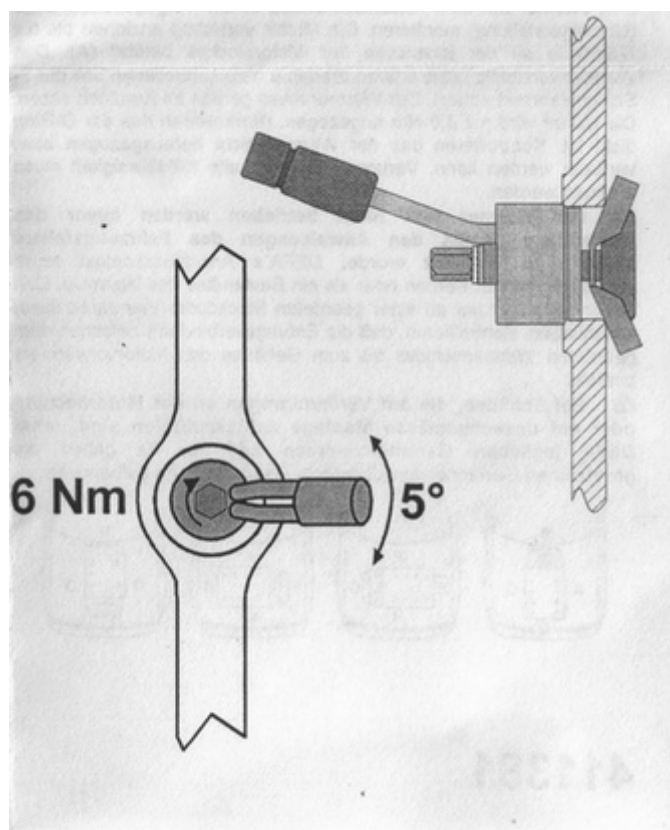

OPEL COMBO 1.7 D (X17D), CORSA 1.7 D (X17D).

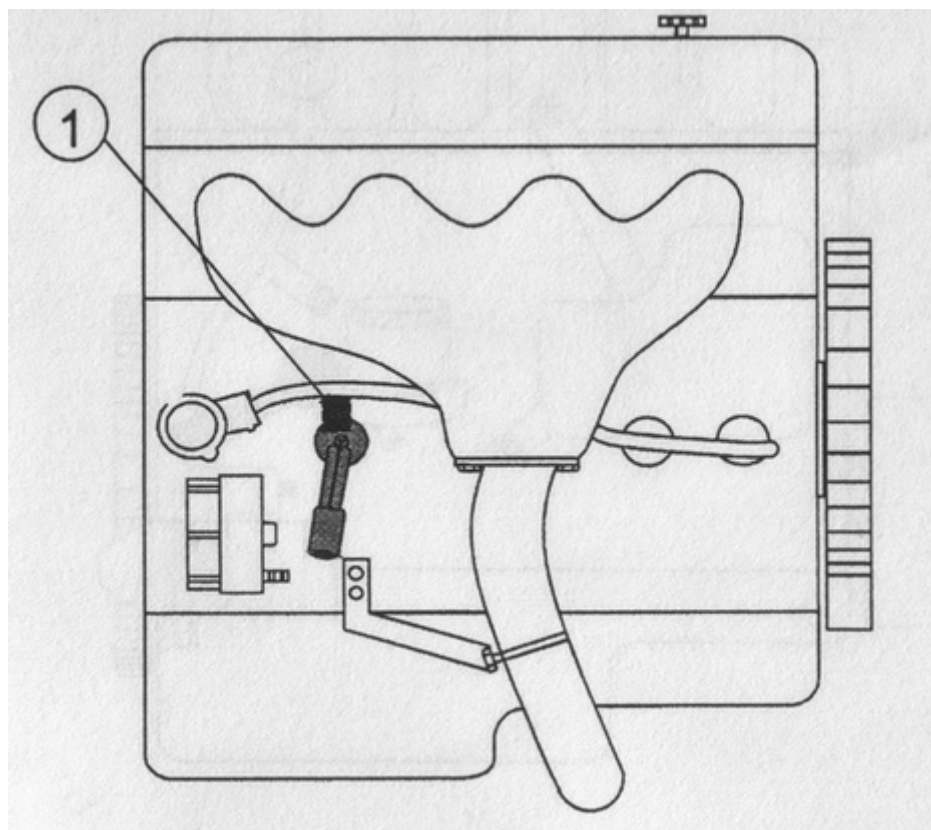

TOYOTA COROLLA GTi

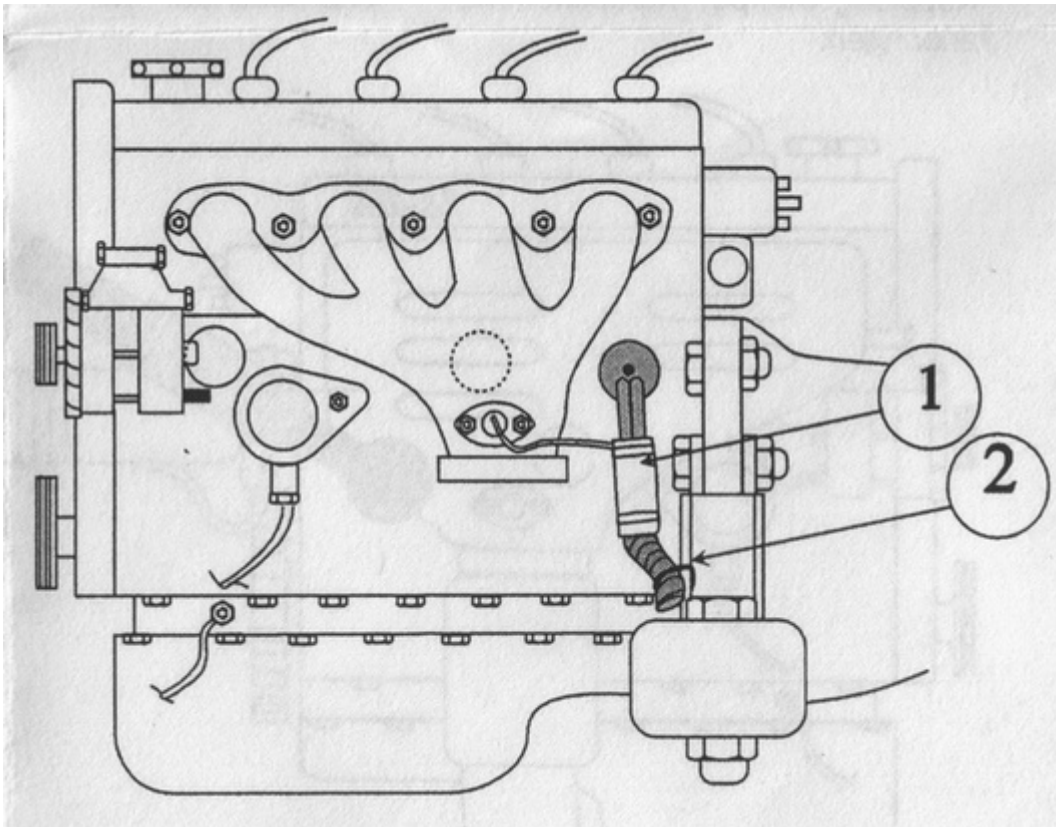

TOYOTA COROLLA 1.8 (98-99)

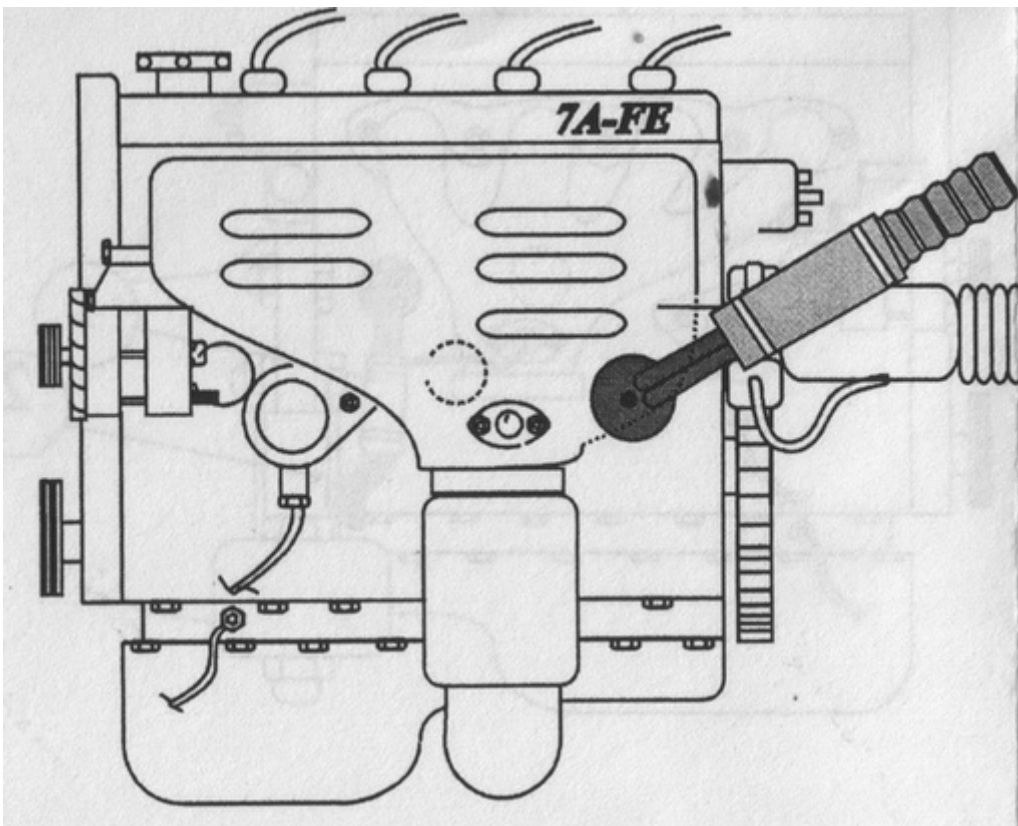

TOYOTA LAND CRUISER 4.2 TD (1HD-FTE)

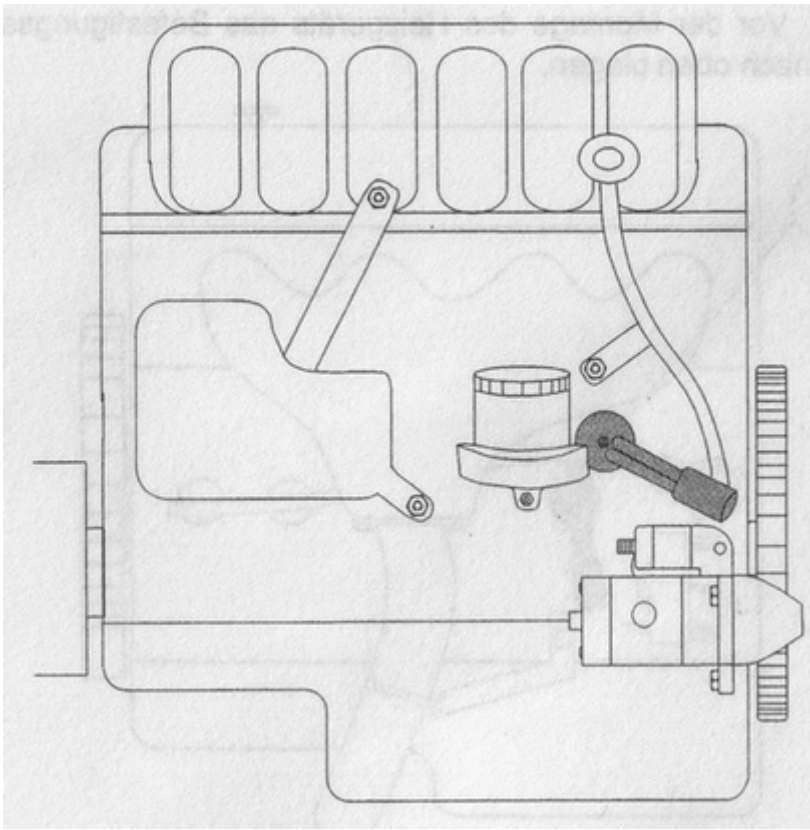

HYUNDAI ACCENT 1.5 (99>)

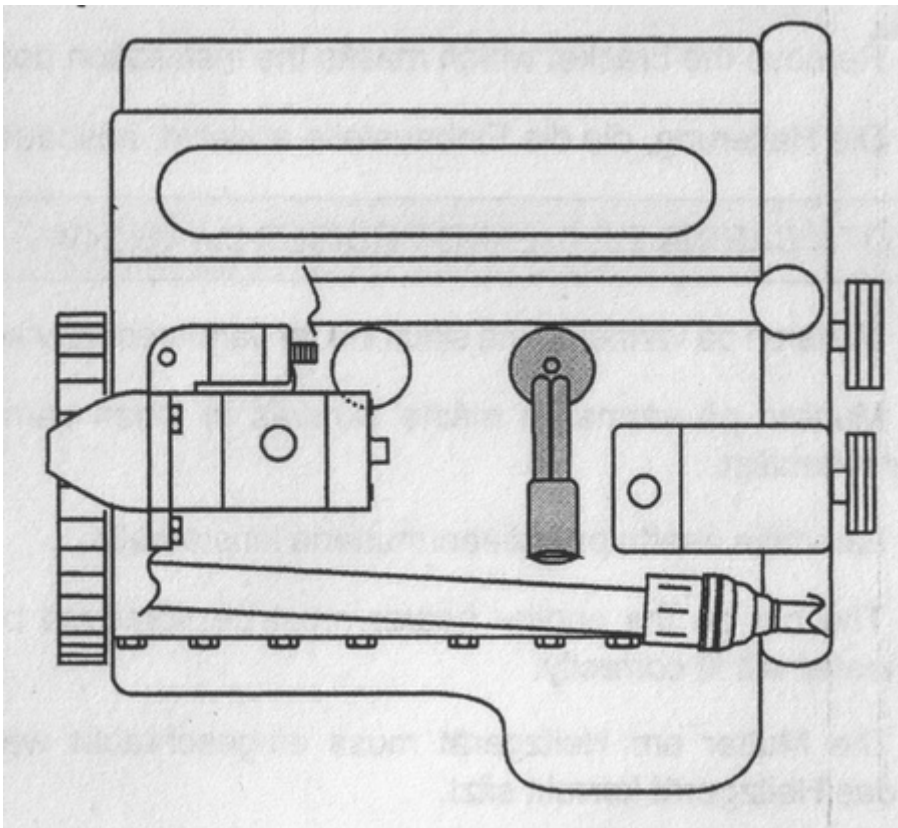

NISSAN PATROL 3.0 D

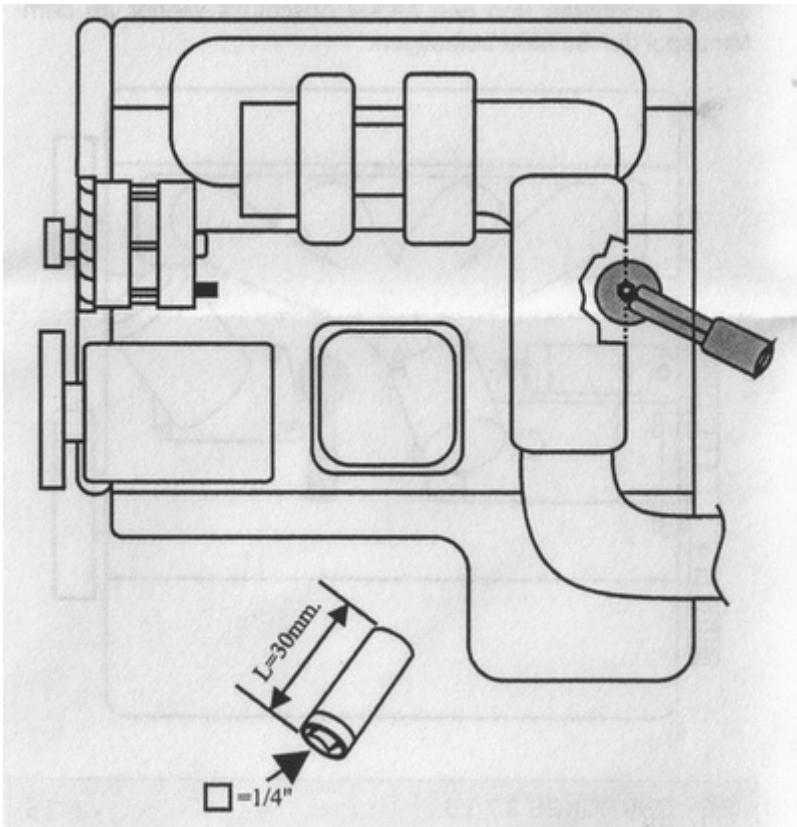

CHRYSLER PT, CHRYSLER 2.0

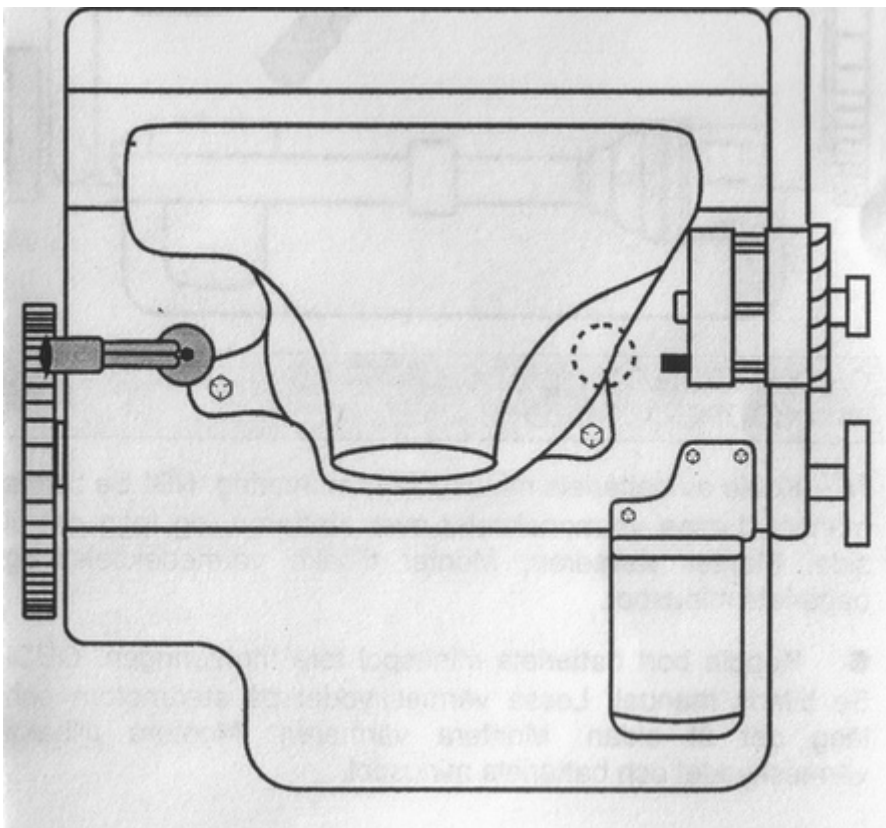

CHRYSLER SEBRING 2.0

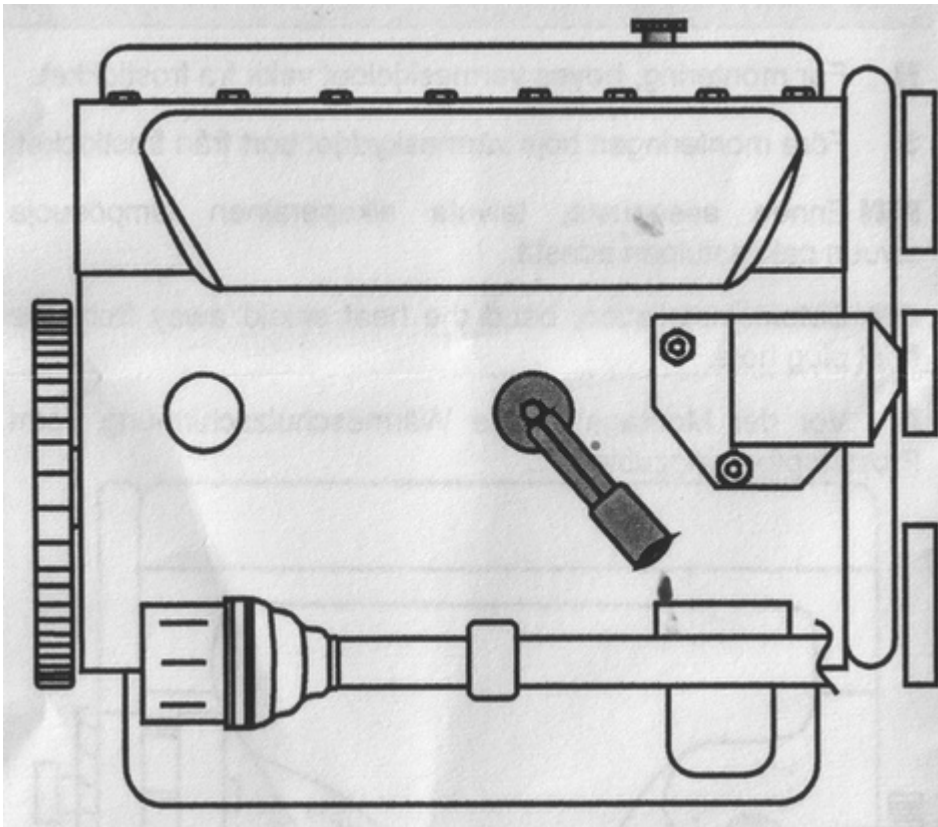

CHRYSLER NEON 1.6, PT CHRYSLER, MINI COOPER, COOPER S, ONE..

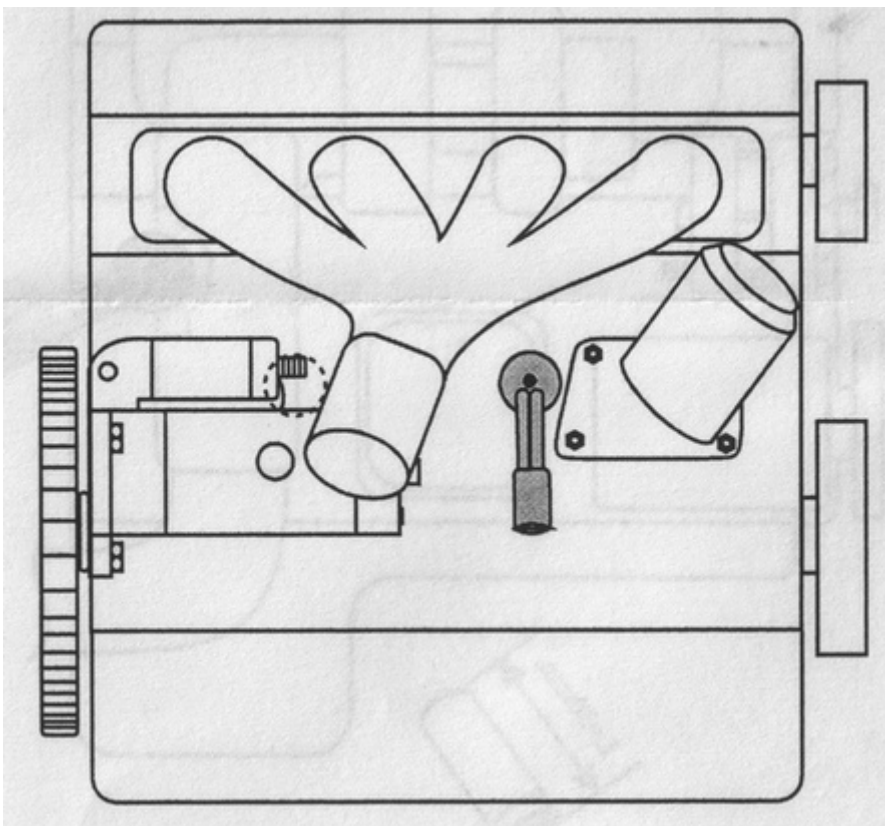

JEEP CHEROKEE 3.7 V6

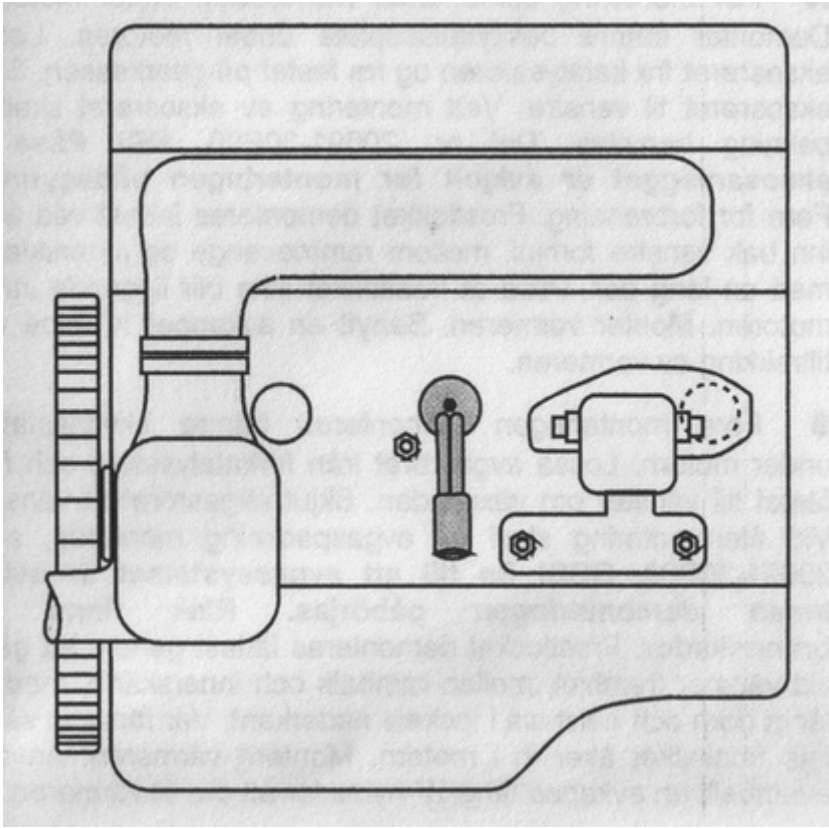

TOYOTA HI ACE 2.5 D-4D, HI LUX 2.5 D-4D

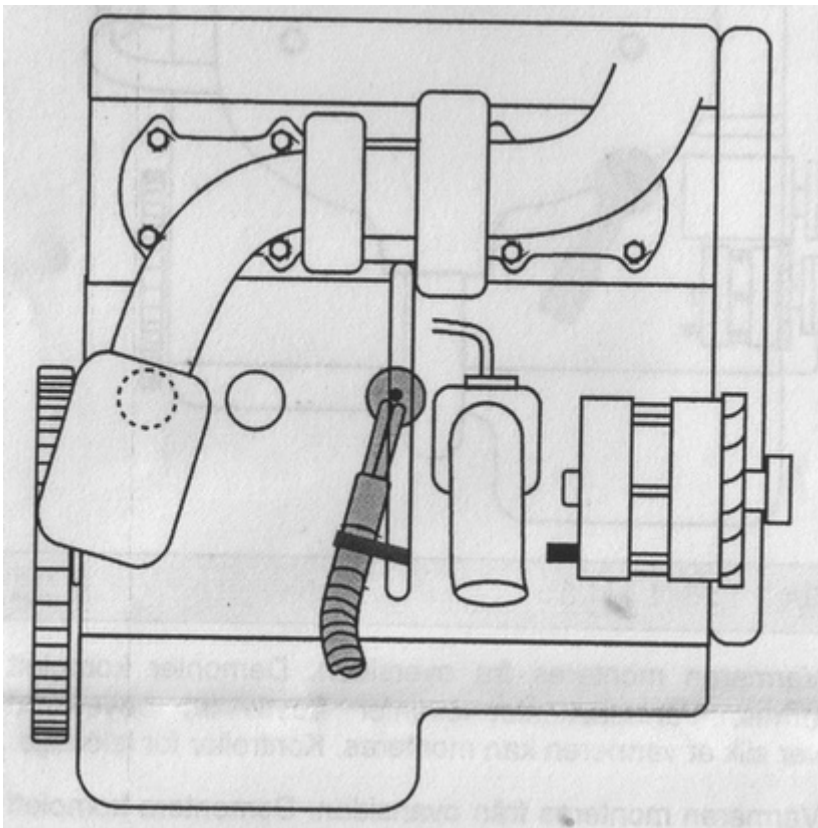

HYUNDAI ACCENT 1.4/1.6, GETZ 1.6, MATRIX, GETZ 1.4

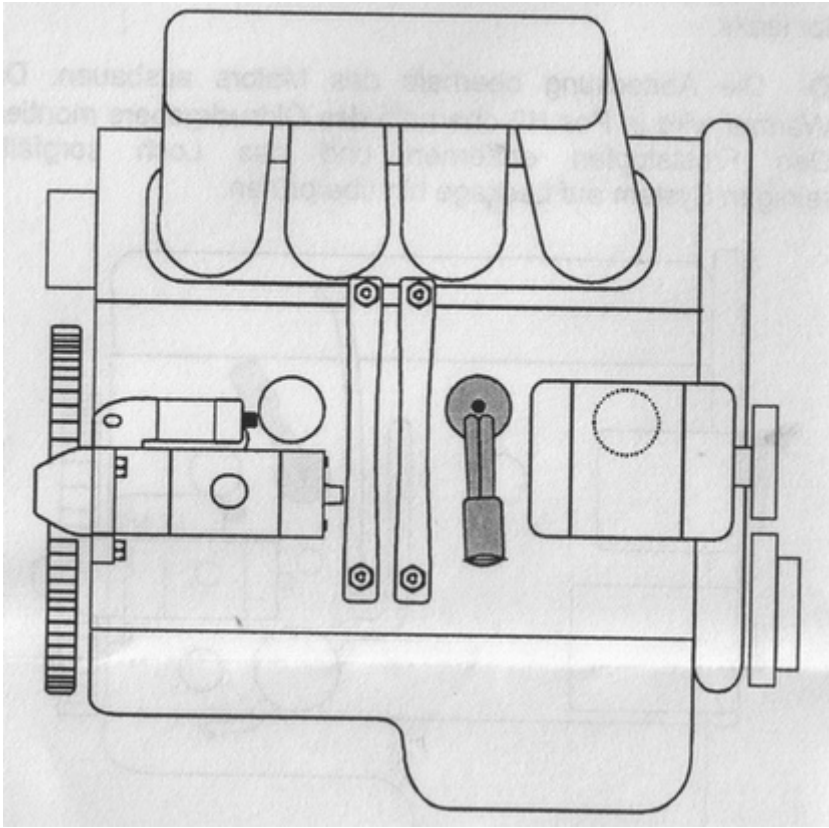

HYUNDAI GETZ 1.3

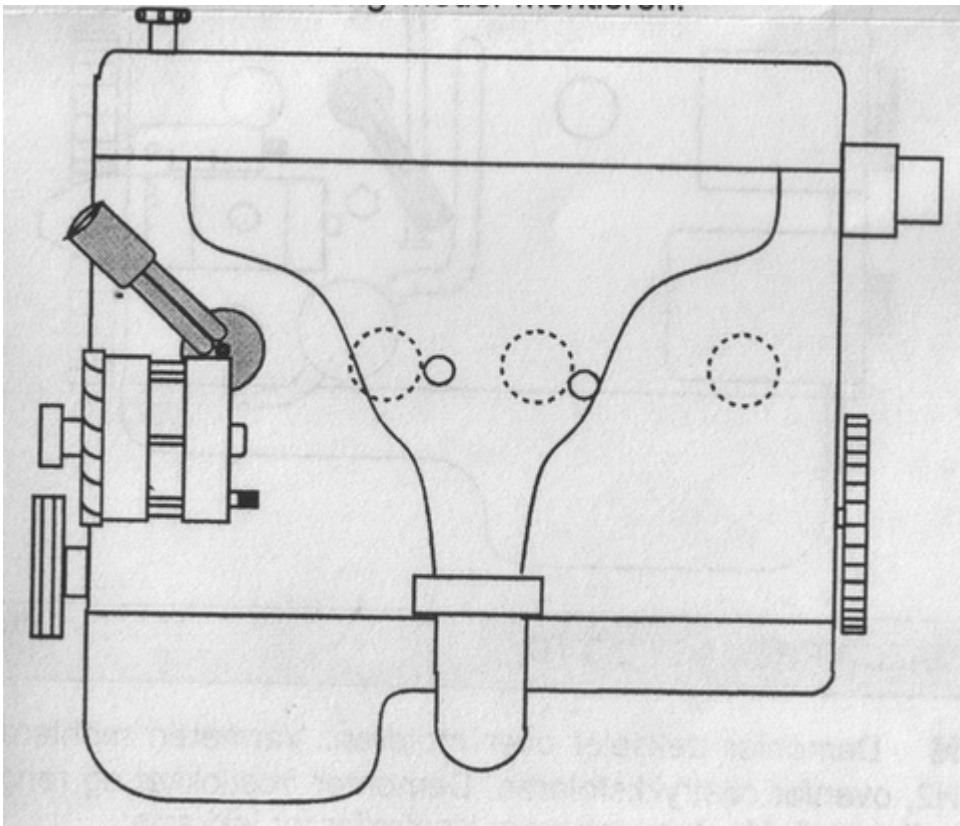

MAZDA MPV 2.0 TD

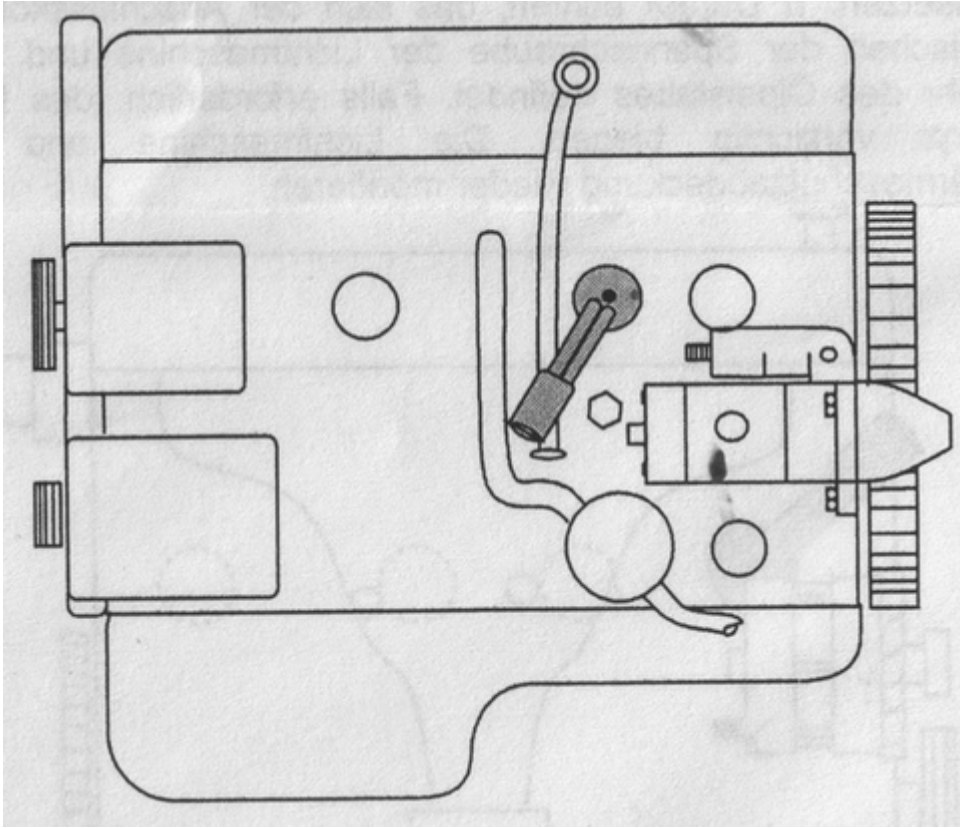

KIA SORENTO 2.4

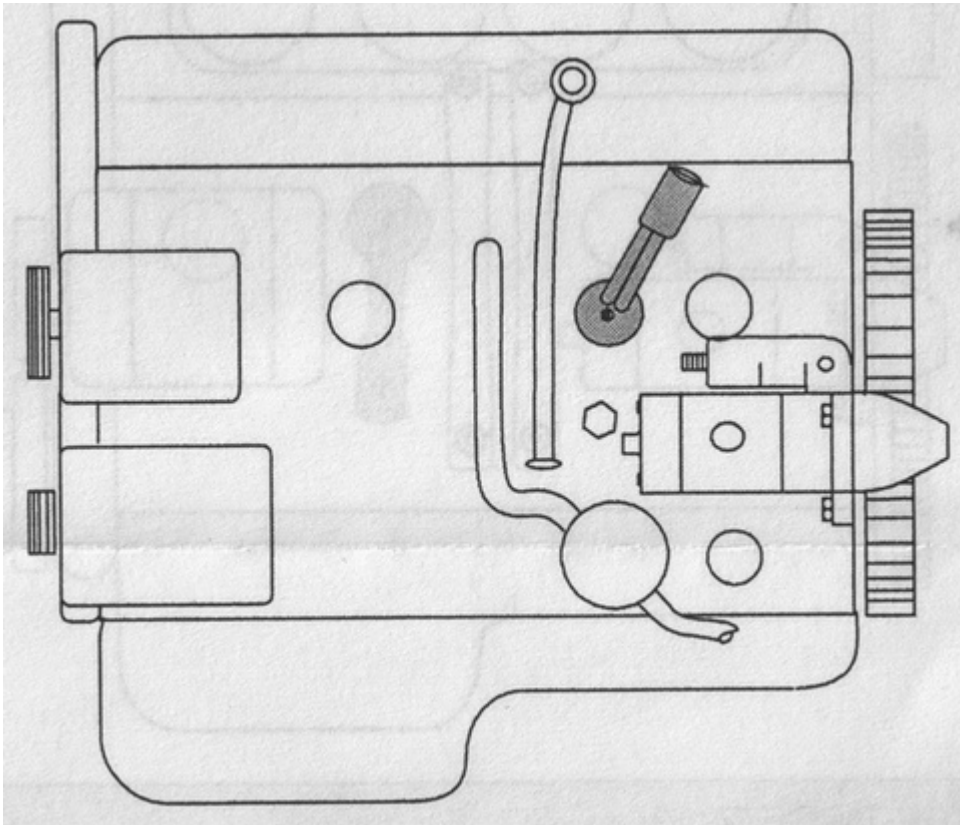

MAZDA 2, 1.25, 1.4, 1.6

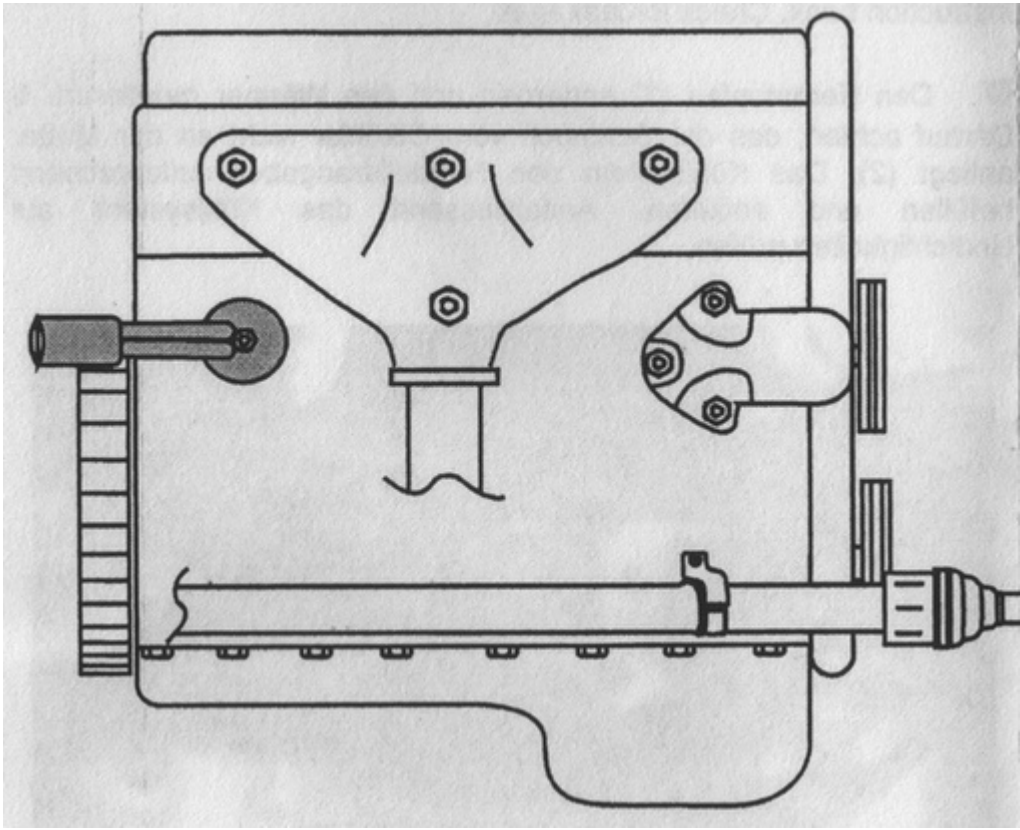

CHRYSLER PT CRUISER 2.4 GT

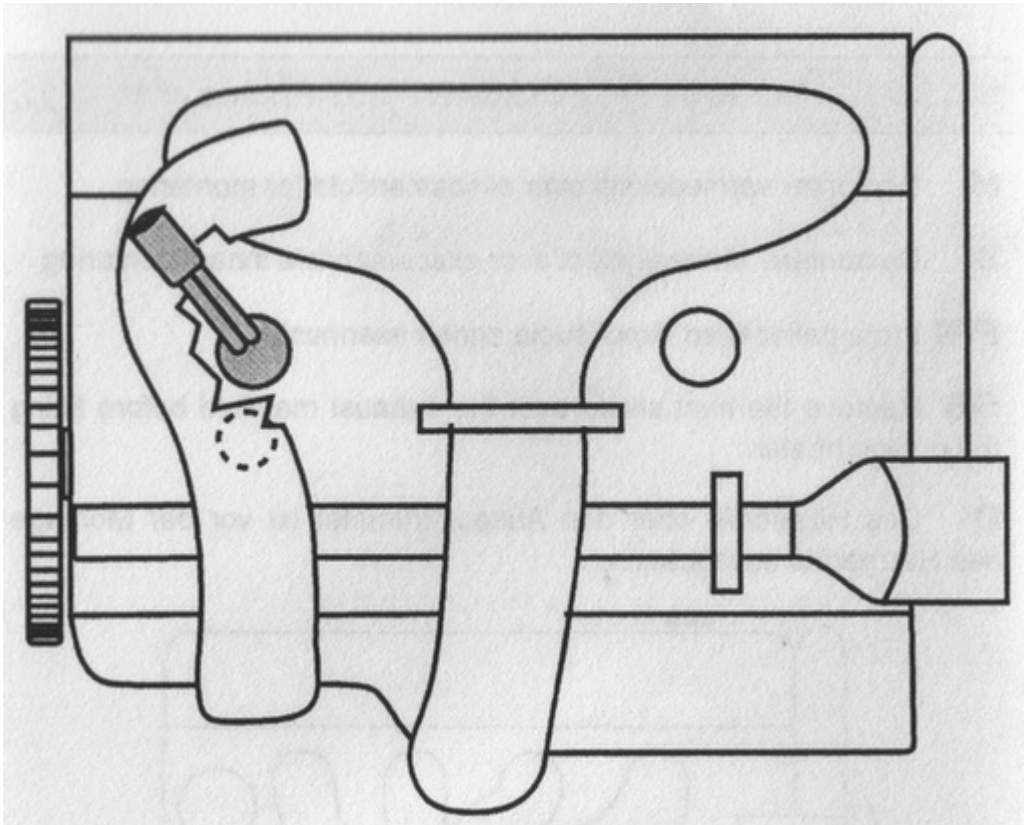

FORD FOCUS C-MAX 1.6, FOCUS 1.6

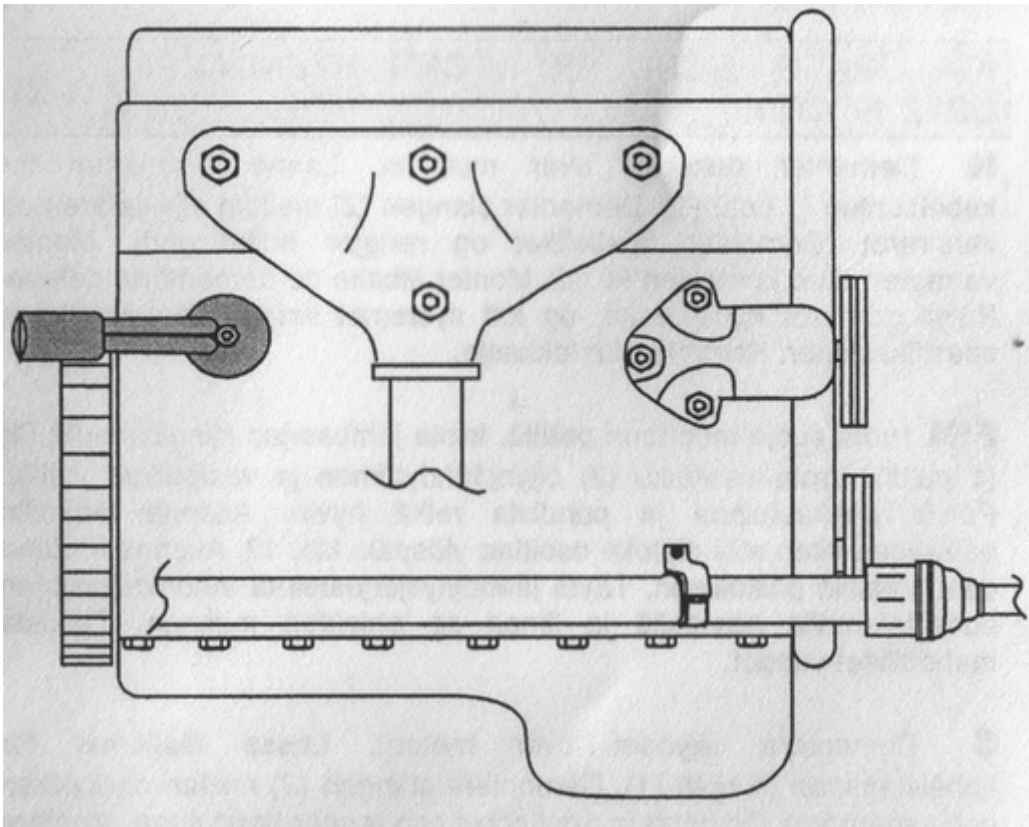

VOLVO S40 1.6 (B4164S3), V50 1.6 (B4164S3)

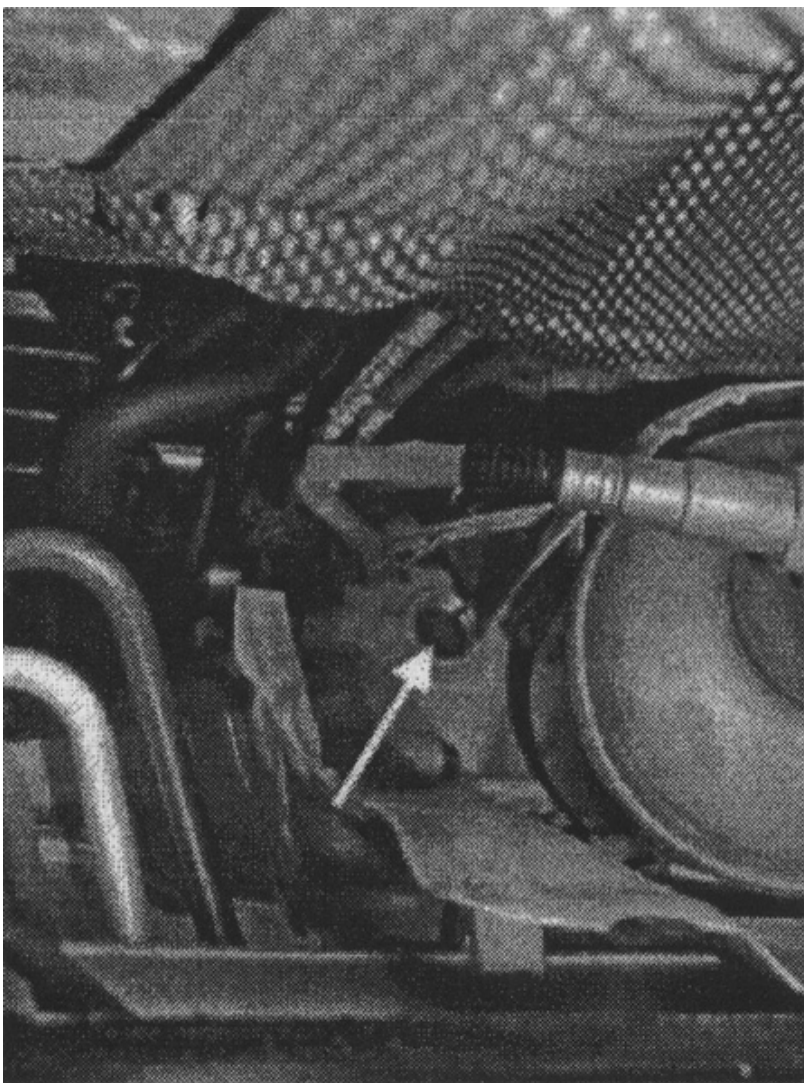

KIA CERATO 1.5 CRDi, RIO 1.5 CRDi, HYUNDAI GETZ 1.5 CRDi

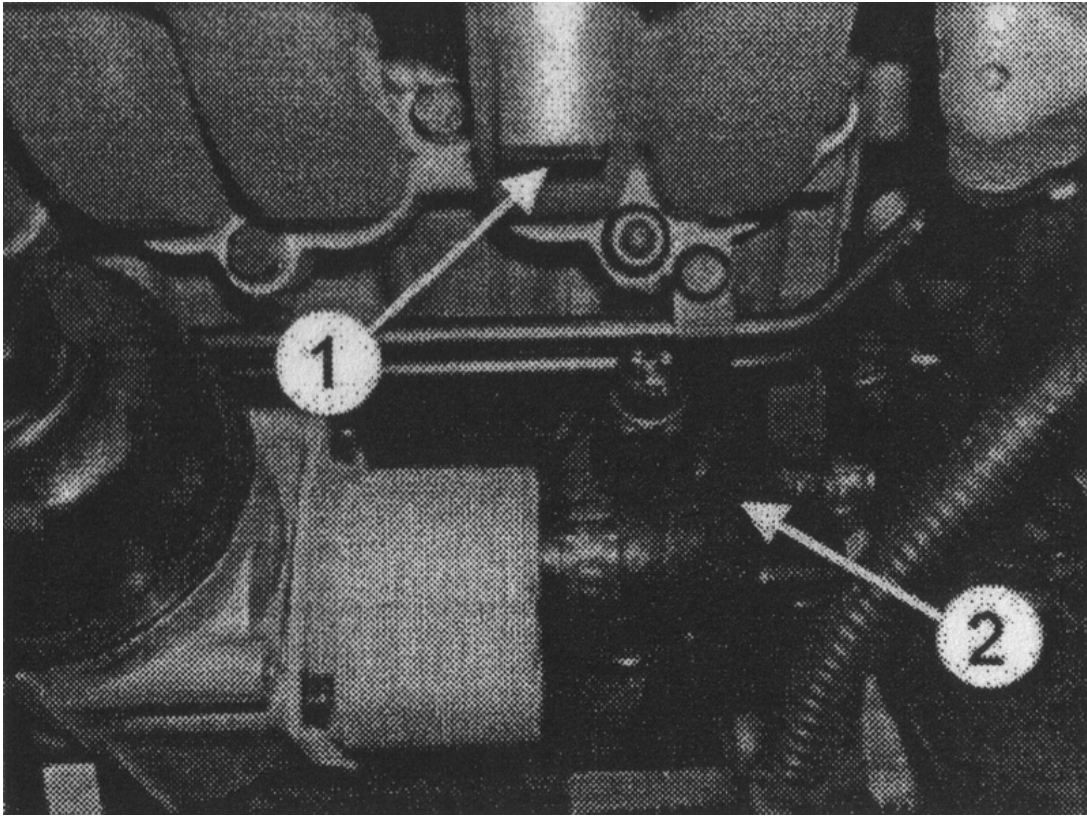

mitsubishi colt 1.5 CZT / SMART 1.5 T Brabus

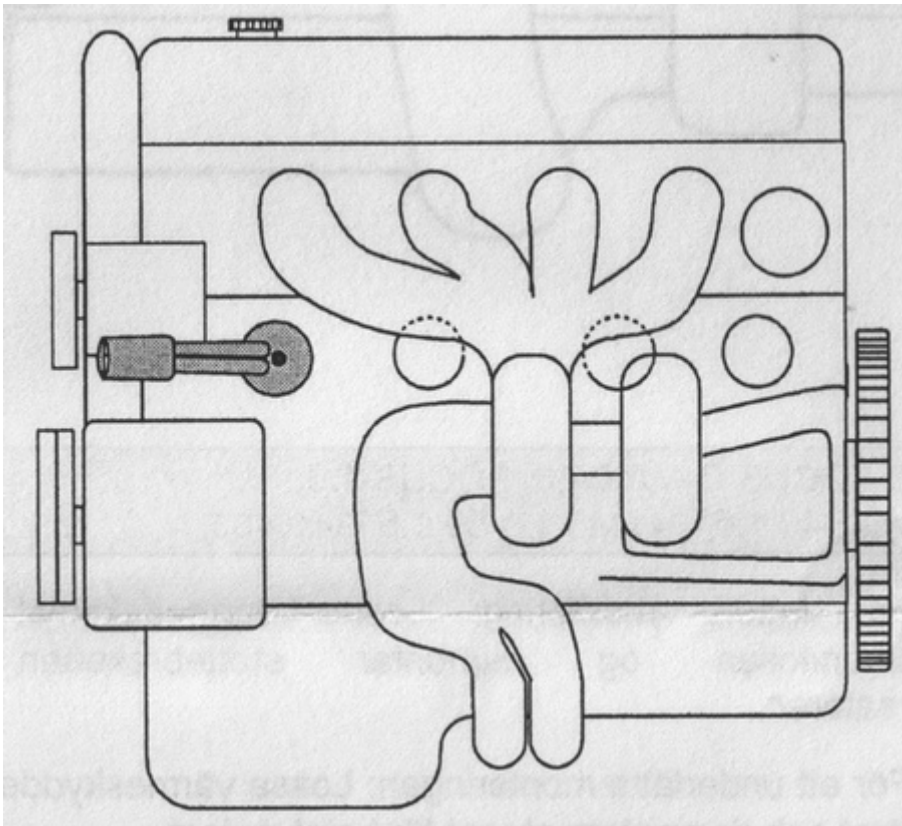

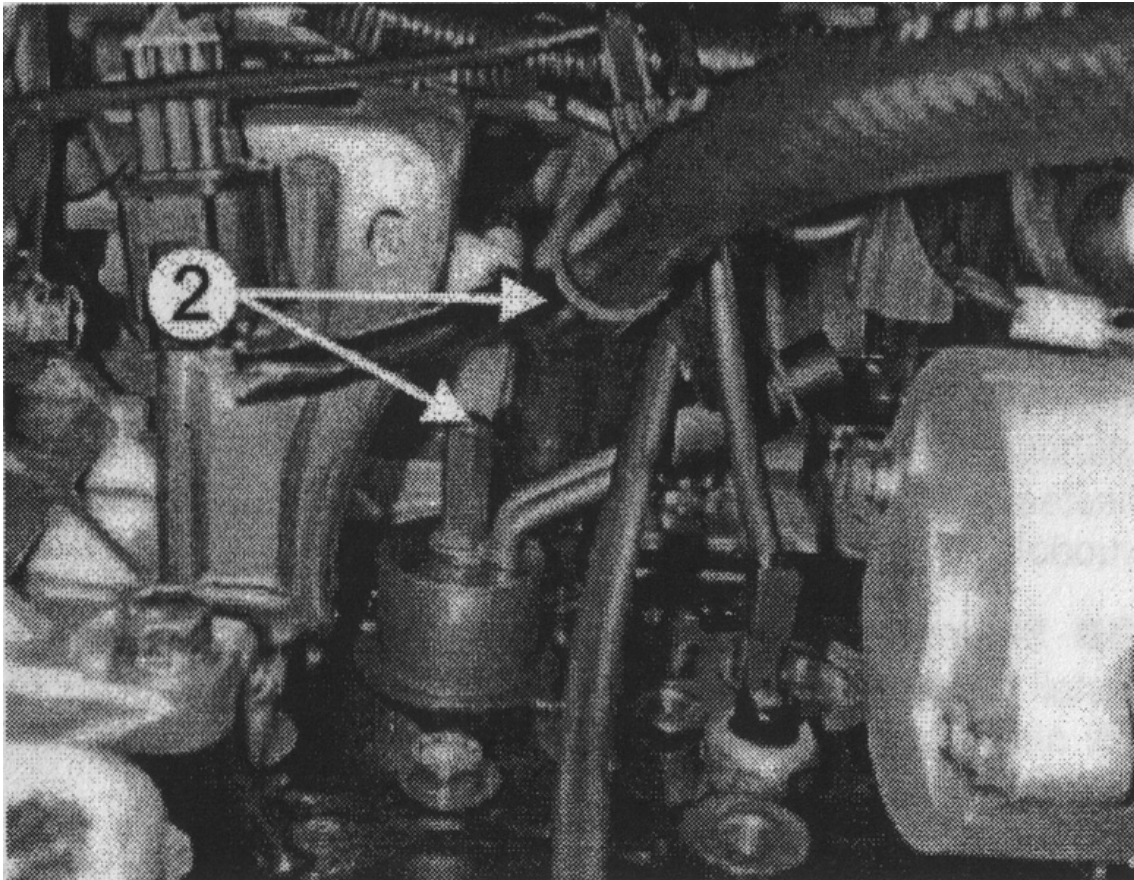
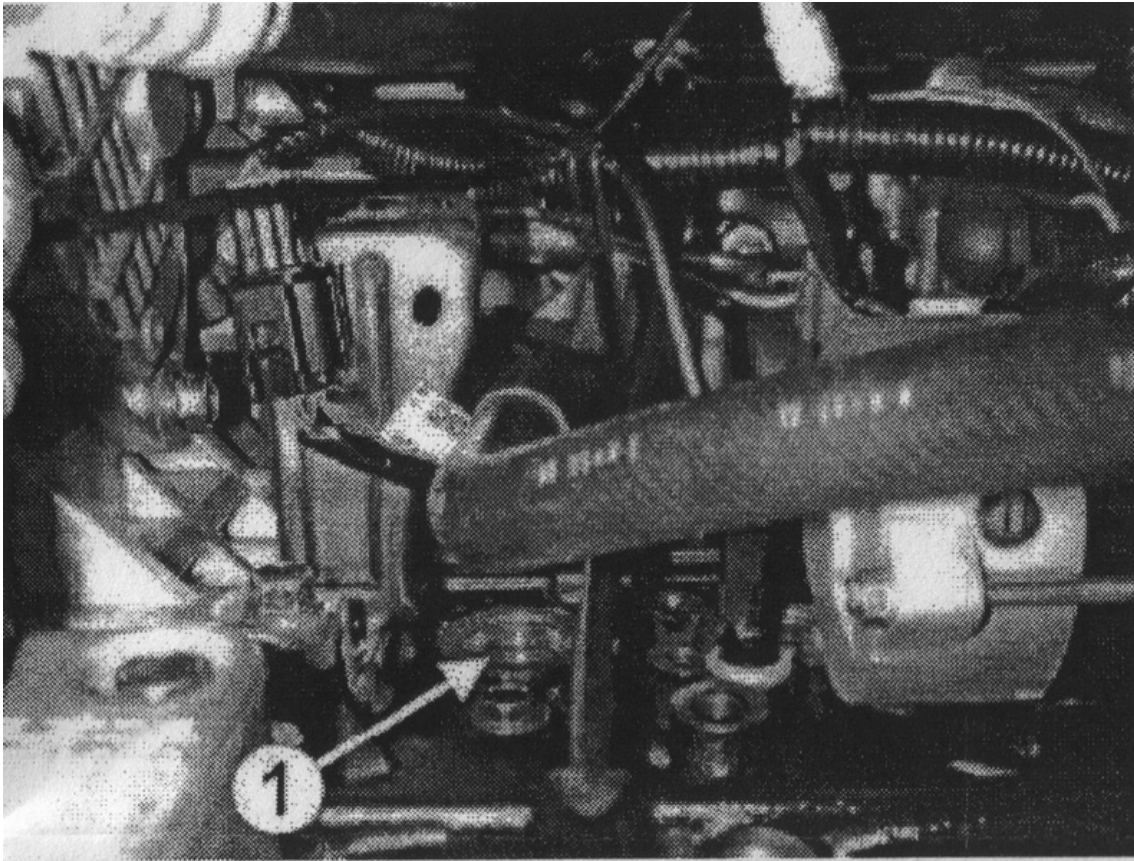

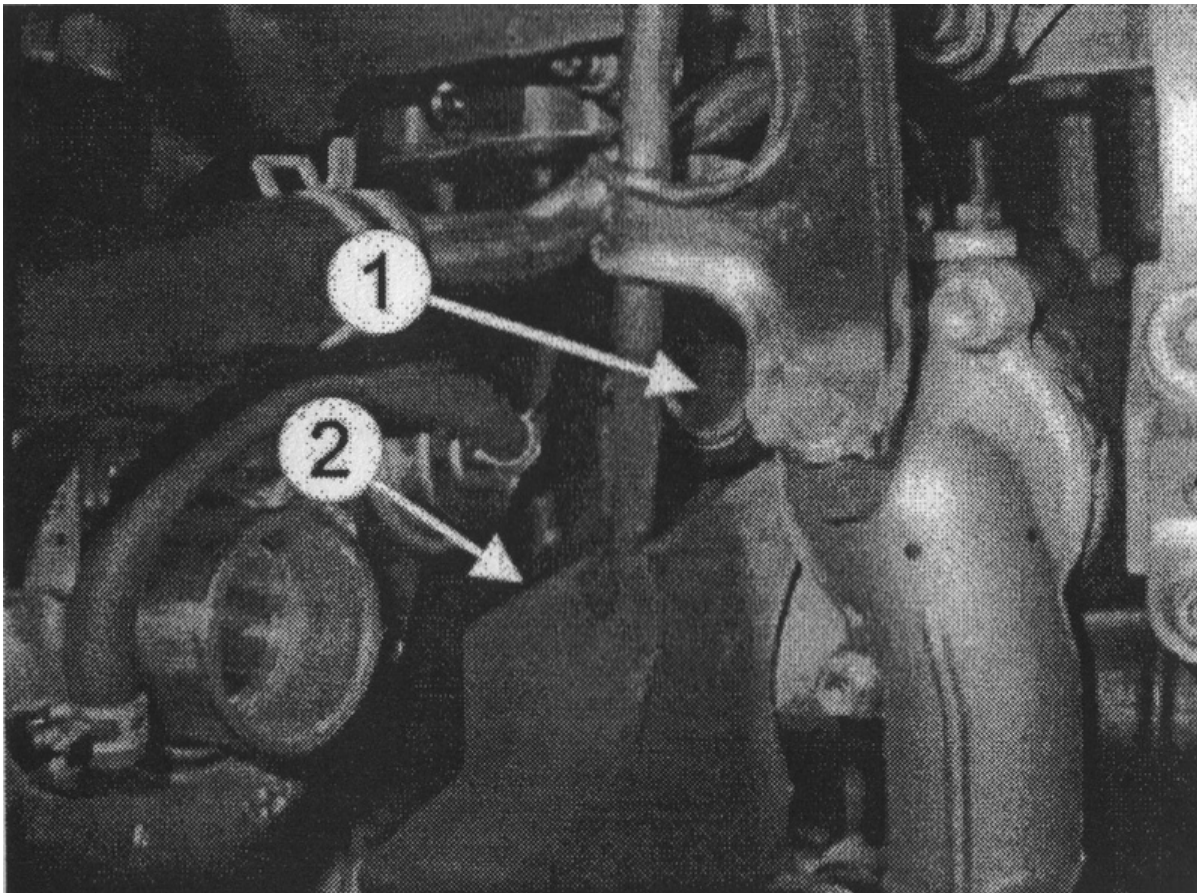
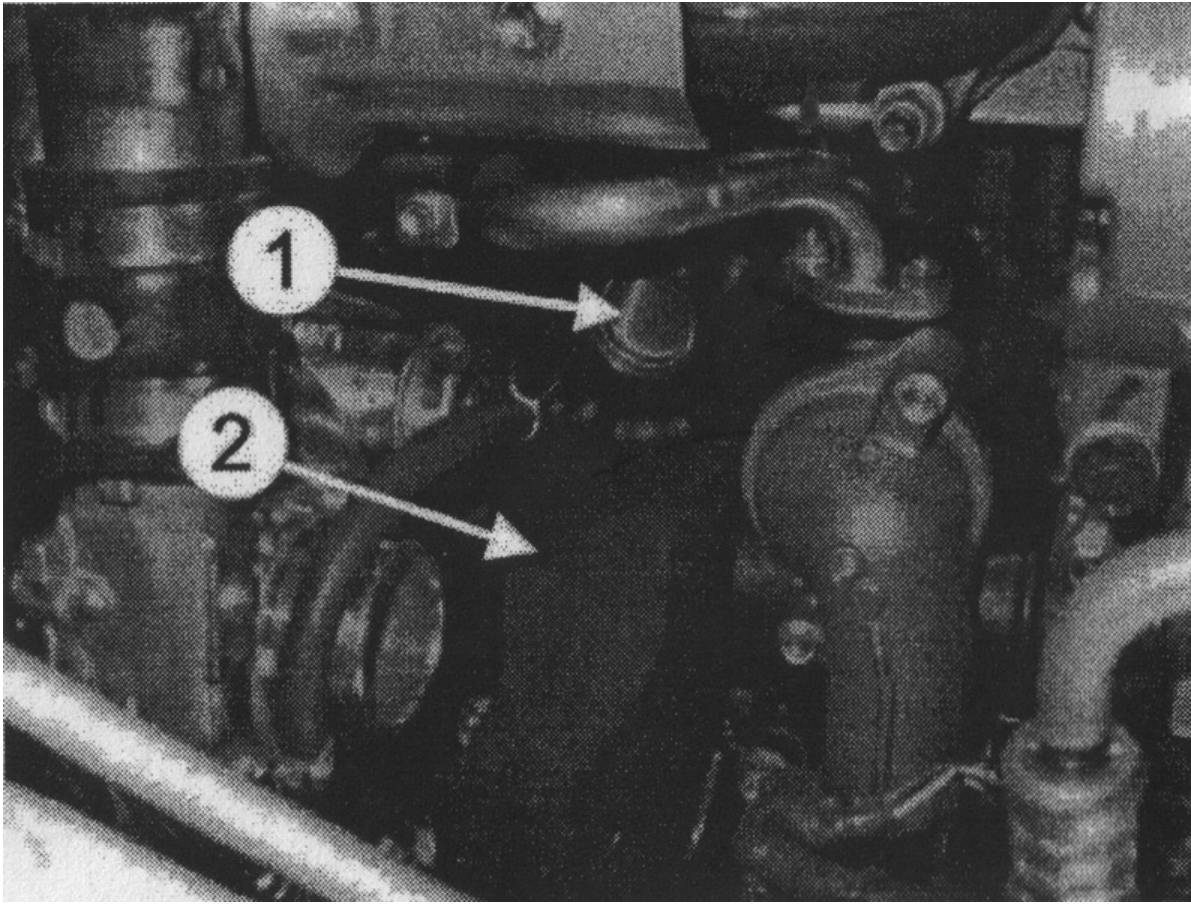

MAZDA BT 50 2.5 MZR-CD

